

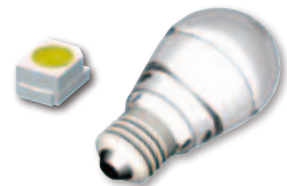

< Measurement image > TM 6101 consists of main unit + sensor unit + PC application software.
(PC is not included)



< Primary measurement application >
White LED/LED lighting devices



Optical characteristic measuring instrument for White LED and LED lighting devices

Featuring new judgment and ranking functionality

Model TM6101 LED OPTICAL METER is an optical characteristic measuring instrument ideal for production lines of White LED and LED lighting devices. Based on HIOKI's proprietary measuring method (Filter spectroscopic method), the TM6101 measures optical characteristics (Luminous intensity, Chromaticity and Color rendering index, etc.) of white LEDs with ultra high accuracy and offers faster speed of measurement compared to a high-precision spectrometer. The TM6101 also offers simpler operation than a spectrometer and can be used to measure color rendering properties. Additionally, updated software functionality provides the ability to generate PASS/FAIL judgments and rank measured values, making the TM6101 ideal for embedding on lines used to test LED lighting.

Feature 1 Simple measurement (simple operation and auto-range capability)

3 Start/stop measurement

1 Dark compensation function

Cancels the optical sensor offset to allow high-precision measurement.

2 Auto-range function

Optimally sets the instrument's range (integration time or sensitivity) based on the amount of light generated by the target light source.

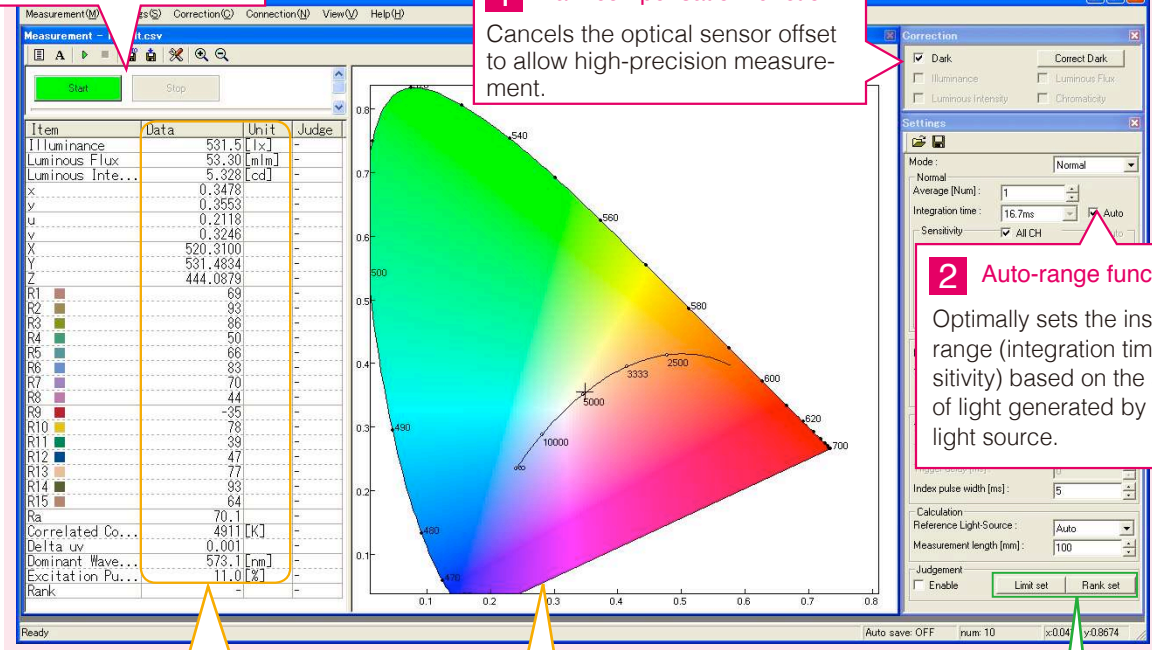

Measurement results display

Displays results including illuminance, luminous intensity, chromaticity, color rendering properties, and color temperature.

Chromaticity graph

Displays the measured chromaticity values (x, y). The graph can be enlarged for easier viewing.

To Features 4 and 5

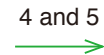

Introduction to measurement methods

Example measurement of an LED lamp

(Measuring the illuminance, chromaticity, color temperature, and color rendering properties of a lamp)

The lamp and light sensor unit should be positioned so that the distance between the lamp and the unit is at least 10 times the size of the lamp. Baffles are placed in front of the light sensor unit to keep out reflected light from walls, the floor, and other surfaces. The lamp's luminous intensity can be calculated from its illuminance using a conversion formula.

Conversion formula for calculating luminous intensity from illuminance:

$$\text{Luminous intensity [cd]} = \text{Illuminance [lx]} \times (\text{Distance [m]})^2$$

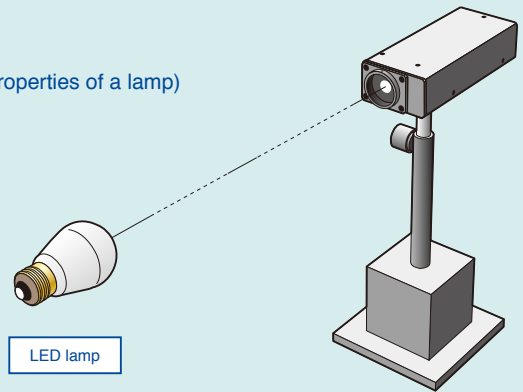

Example measurement of an LED fluorescent lamp

(Measuring the illuminance, chromaticity, color temperature, and color rendering properties directly underneath a fluorescent lamp)

Illuminance is measured directly underneath a fluorescent lamp. The measurement reference surface of the light sensor unit should be positioned a suitable distance from the fluorescent lamp, for example 1 m or 1.5 m.

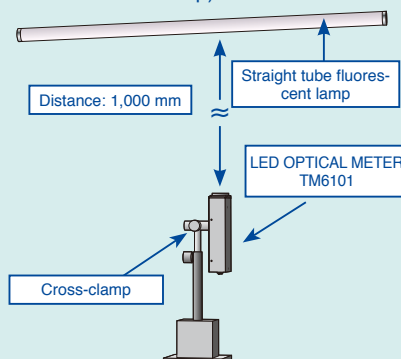

Positioning the sensor unit

Use the M4 screw holes on the bottom of the sensor unit to fasten it in place. When affixing the unit to a workbench, provide a rod (12 mm in diameter), rod stand (sized for a 12 mm rod), and magnetic base.

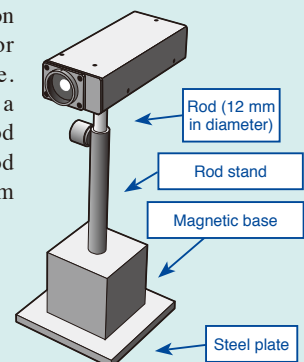

Note: User is responsible for providing a stand and other equipment needed to install the sensor unit.

Feature 2 Measurement of color rendering properties

(for quantification of the quality of LED lighting)

Lighting with superior color rendering properties is highly desirable in settings such as stores, homes, and restaurants. In particular, lighting with a high color rendering index of R9 is desirable in order to create fresh, vivid reds in fresh food. The TM6101 provides color rendering property measurement capabilities that are impossible to replicate with Tristimulus Colorimeters or Luminance & Color Meters.

Color rendering properties

Objects of the same color may look different when lit by different light sources. The effect of a light source on the appearance of an object's color is known as its color rendering properties. Typically, the light source's color rendering properties are considered to be good to the extent that the illuminated object's appearance approaches that when lit by natural light (sunlight).

The appearance of colors varies with the light source's color rendering properties.

Reference light

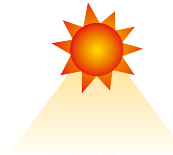

Light source being evaluated

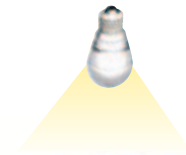

Revisions to JIS Z9110-2010 (General Rules of Recommended Lighting Levels) (Revised January 2010)

General color rendering index and other qualitative lighting requirements were added to illuminance standards that previously consisted only of recommended illuminance levels.

* Color rendering properties cannot be measured with a Tristimulus Colorimeters.

Color rendering index

The color rendering index provides a quantitative indication of the color shift that occurs when a color chart used for evaluating color rendering properties (the chart consists of test colors defined by CIE and JIS) is lit with the light source being evaluated. A value of 100 is used to indicate color appearance under the reference light, and smaller numbers indicate greater divergence in color.

General color rendering index (Ra)

Average value of color rendering indexes 1 through 8

Smaller value = Large color shift

Larger value = Good color reproduction

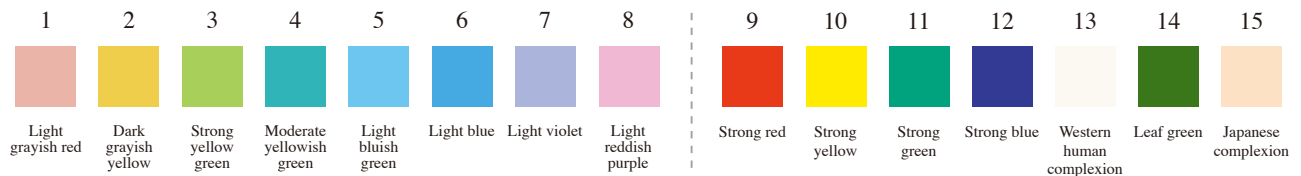

Example LED lamp measurement results

(1) Lamp with good color rendering properties

(2) Lamp with poor color rendering properties

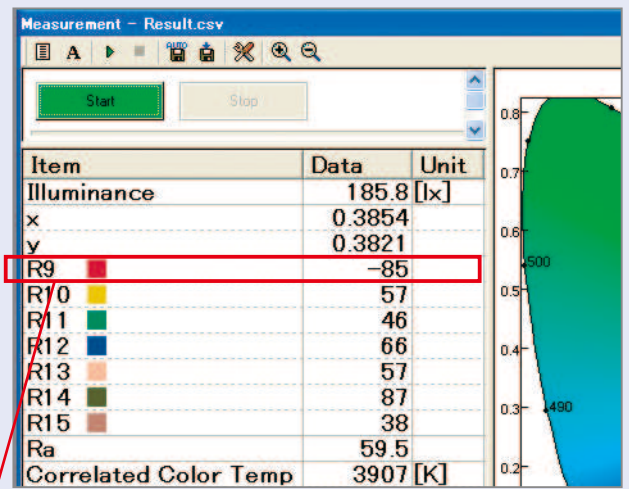
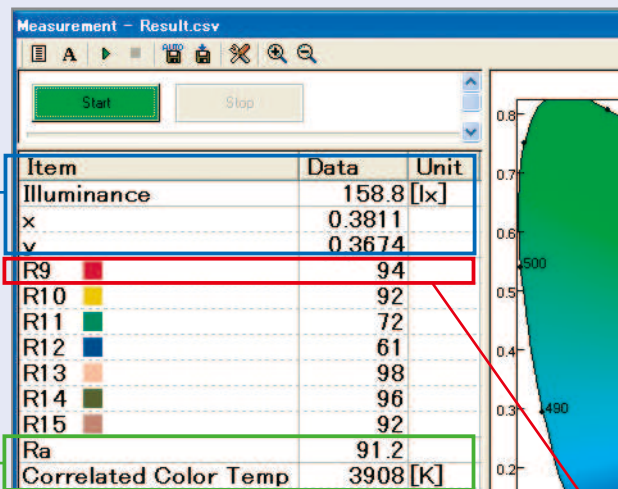

Illuminance value = 158.8 [lx]
Chromaticity value (x) = 0.3811
Chromaticity value (y) = 0.3674

Correlated color temperature = 3908 [K]
General color rendering index (Ra) = 91.2

Color rendering index
(1) R9 = 94
(2) R9 = -85

Lamp (1) has better color rendering properties.



Feature 3 High-precision chromaticity measurement

Thanks to a proprietary measurement system, the TM6101 can measure chromaticity at a higher level of precision than is possible with conventional tristimulus-type color illuminometers or color luminance meters.

Chromaticity

Since there is significant variation in the color of light produced by LEDs, testing and selection based on chromaticity are necessary.

The color of light is determined by three values (X, Y, and Z) known as tristimulus values. The X, Y, and Z values add up to 1, and the X and Y values comprise the chromaticity (x, y), which expresses the color.

$$x = \frac{X}{X+Y+Z} \quad y = \frac{Y}{X+Y+Z}$$

Chromaticity is expressed as a point on a chromaticity diagram defined by the International Commission on Illumination (CIE). The center of the diagram corresponds to the color white, with the colors growing more vivid as you move toward the periphery.

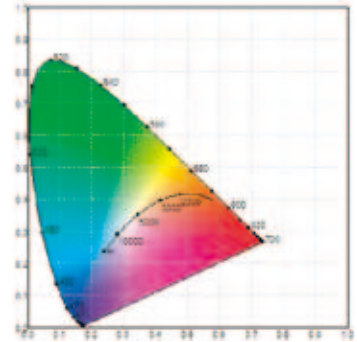

XY Chromaticity Diagram (CIE 1931 chromaticity diagram)

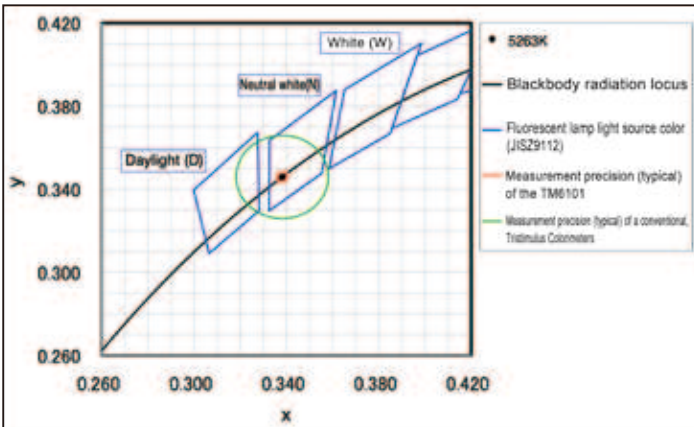

When using a measuring instrument with poor precision in chromaticity ranking testing, compliant products may be falsely found to be defective, and defective products may be falsely determined to be compliant. For example, the TM6101 offers sufficient performance to make accurate PASS/FAIL judgments when using the light source color (neutral white: N) defined in JISZ9112 as the test range. If the rectangular region defining performance is larger than the test range, a compliant target (a 5,000 K light source) may be judged to be defective. In short, a high-precision chromaticity measuring instrument is essential in order to make accurate PASS/FAIL judgments. The conventional method of dispersing light into a spectrum for measurement is considered to provide good precision, but some implementations suffer from precision degradation caused by optical performance issues (wavelength precision, stray light, etc.). Thanks to its proprietary measurement system, the TM6101 delivers an equivalent level of high precision.

Feature 4 Ranking function

By ranking the chromaticity of white LEDs used in LED lighting at a high level of precision, it is possible to produce lighting with very little color variation (up to 256 ranks can be used). Additionally, it is possible to subject measurement targets to PASS/FAIL testing by specifying which ranks can be used in production and which should be considered defective.

[Rank settings: Neutral white, daylight, white, warm white, incandescent lamp]

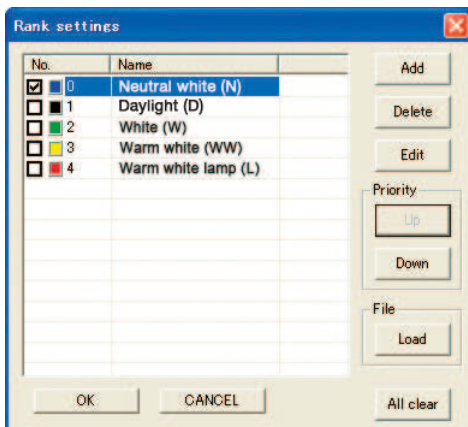

Rank setting screen

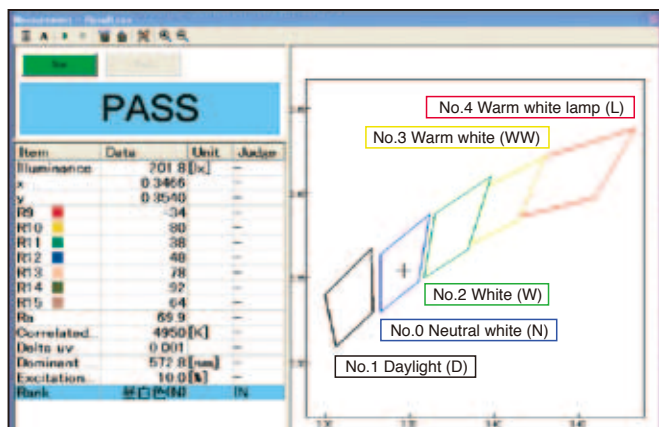

Measurement results screen

Feature 5 Judgment function (for improving testing speed and reliability)

A variety of tests are used in the production of LED lighting due to variations in the brightness and color of white LEDs. For example, when using multiple test standards such as brightness, general color rendering index, and correlated color temperature, workers must make PASS/FAIL judgments by checking whether each value falls within the test standard range.

Example test conditions

Illuminance: 500 lx or greater

General color rendering index (Ra): 70 or greater

Correlated color temperature: Greater than or equal to 4,500 K and less than or equal to 5,500 K

Item	Data	Unit	Judge
Illuminance	559.7	[lx]	IN
x	0.3469	-	-
y	0.3515	-	-
Ra	70.7	-	IN
Correlated Color Temp	4931	[K]	IN
Delta uv	-0.001	-	-

Illuminance test standard 500 lx or greater

Item	Data	Unit	Judge
Illuminance	490.9	[lx]	LO
x	0.3468	-	-
y	0.3513	-	-
Ra	70.7	-	IN
Correlated Color Temp	4935	[K]	IN
Delta uv	-0.001	-	-

FAIL judgment since the illuminance is less than 500 lx

Feature 6 Stable measurement of LEDs driven by commercial power

AC-lit measurement mode

While white LEDs are typically driven with DC current, some types can be driven by commercial AC power sources, in which case the brightness fluctuates with the commercial power frequency. By using AC-lit measurement mode to synchronize the integration time with the commercial power period (50 or 60 Hz), the TM6101 achieves stable measurement of the optical characteristics of this type of white LED.

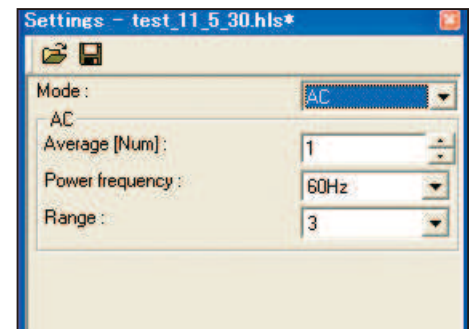

Settings screen

Feature 7 Data Logging Function

- (1) The TM6101 can save measurement results at a user-specified time interval.
- (2) As an example application, this functionality can be used to evaluate variations in LED lighting brightness over time. Typically, the temperature increases when LED lighting is turned on, leading to variations in brightness and color caused by white LEDs' temperature dependence. The TM6101's data logging capability can be used to verify that improvements in the heat-dissipating structure of a particular LED lighting unit are reducing the magnitude of these changes immediately after the light is turned on.

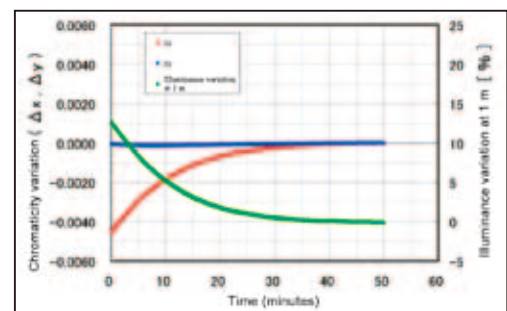

Example graph of logging data

Ideal for testing LED devices

Newly developed high-precision filter system delivers high speed and high precision

High-precision filter spectral and calculation processing help the optical sensor's sensitivity approach CIE color matching functions, allowing high-precision light and color measurement. The sensor consists of a photo diode array and uses minute current measuring technology to deliver a high signal-to-noise ratio and high dynamic range.

Improve productivity (Fast measurement with high accuracy)

- Integration time can be set from **0.1msec at its fastest**.
- Rapid measurement with approx. **5msec at its fastest**.
(incl. communication and calculation time)
- **High SN ratio**, stable measurement with short integration time.

In order to allow high-speed testing of optical characteristics such as LED brightness, chromaticity, and color rendering index, HIOKI engineers designed the TM6101 to accelerate measurement times while delivering a high signal-to-noise ratio. This high signal-to-noise ratio enables stable measurement even when integration times are short, speeding testing by reducing total measurement time including communications and calculation time.

Did you know?

White LEDs are subject to strict requirements concerning variations in chromaticity. Measuring instruments used to rank chromaticity are required to have a resolution of 0.0001 of the chromaticity value.

Rate chromaticity with high accuracy (High stability testing)

- **Stability of chromaticity values is within ± 0.0001 (3σ)** (integration time 2ms, 1.5cd white LED, measuring distance 30mm)
- **Best accuracy of chromaticity ± 0.002** compared to high-precision spectrometer.

In addition, by adding the reference value compensation function, a best accuracy of ± 0.001 for the same type of LEDs can be achieved.

The TM6101 is capable of stable measurement with variation of just ± 0.0001 of the measured chromaticity value, allowing it to rank LED chromaticity at a high level of precision (see Figure 1).

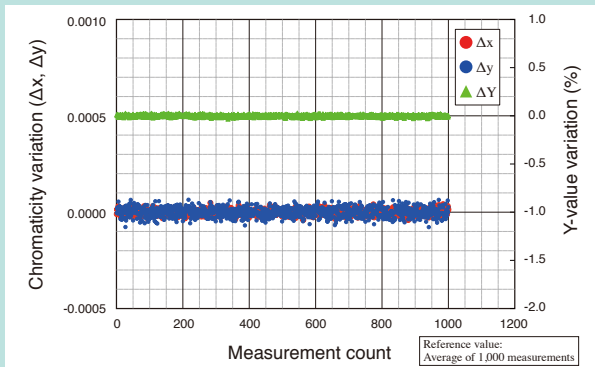

Figure 1. Measured Value Stability
(integration time 2ms, 1.5cd white LED, measuring distance 30mm)

Using a white LED of the same type as the reference light source, the TM6101 limits variability in observed chromaticity values to within ± 0.001 (see Figure 2). Spectral data for the light is required in order to perform reference value correction.

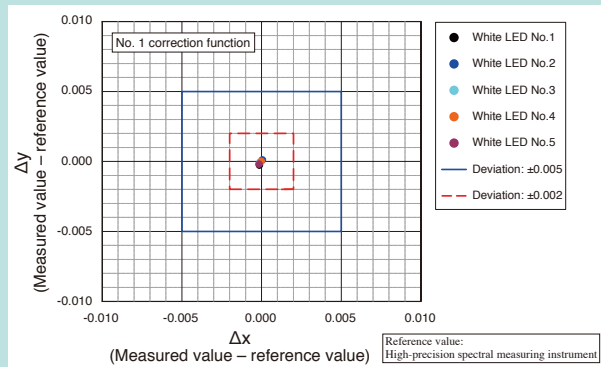

Figure 2. Variability in Chromaticity Values
(Chromaticity measurement results for multiple white LEDs of the same type)

Typically, optical measuring instruments, including high-precision spectral measuring instruments, exhibit instrumental error in chromaticity and luminous flux measurement results. In order to eliminate this source of error, the TM6101 features a reference correction function that uses a reference light source provided by the operator (a standard lamp, etc.). By correcting reference values, the instrument can limit variability in observed chromaticity values for 10 types of white LEDs with different chromaticity values to within ± 0.002 compared to results obtained with a high-precision spectral measuring instrument (see Figures 3 and 4).

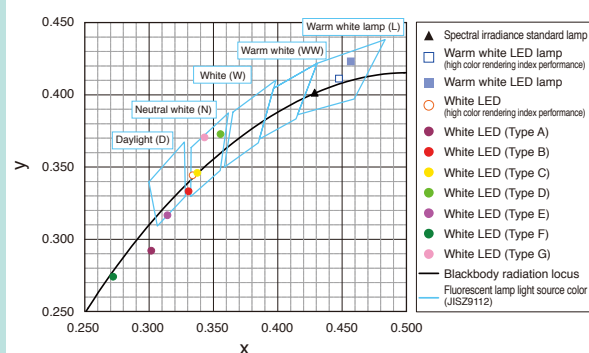

Figure 3. Chromaticity Values
(Chromaticity Measurement Results for 10 Types of White LED)

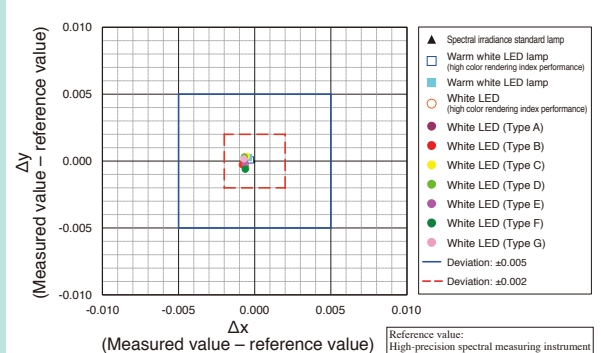

Figure 4. Variability in Chromaticity
(Chromaticity Measurement Results for 10 Types of White LED)

High-precision measurement under various conditions *(Easy to install optical sensor)*

- The optical diffusion sensor makes it possible to use the TM6101 **under various measuring conditions** such as direct measurement of luminous intensity and photometry by using an integrating sphere.
- **Low incident angle dependence:** Influence caused by angle of incidence is **within ± 0.001 for chromaticity** values at its best in the range of ± 60 degrees from the optical axis.
- **Diameter of optical detector plane is large at $\phi 11.3\text{mm}$** , conforming to the aperture area (100mm^2) of an optical receiver, which is specified in JIS C 8152 (measurement of averaged LED luminous intensity). Measurement of LED components from the distance of 100mm is equal to the photometry condition of CIE Condition B that specifies the measuring method of averaged LED intensity.

An LED radiates light at a variety of angles from its optical axis. In order to measure LED light and color at a high level of precision, it is necessary to accurately measure light at a variety of angles. The TM6101 uses an optical diffusion sensor to ensure low incident angle dependence (see Figure 5). For this reason, it is possible to achieve stable chromaticity measurement, even when the measurement distance is varied during axial measurement (see Figure 6).

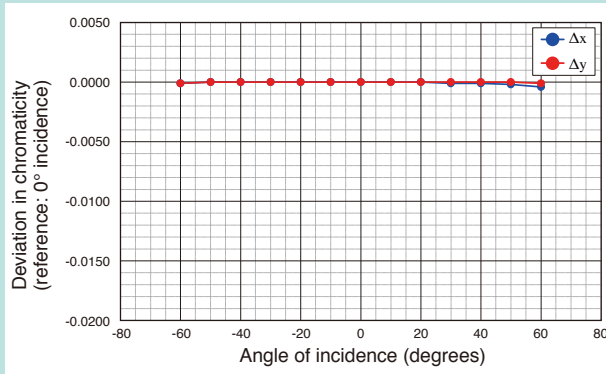

Figure 5. Incident Angle Dependence

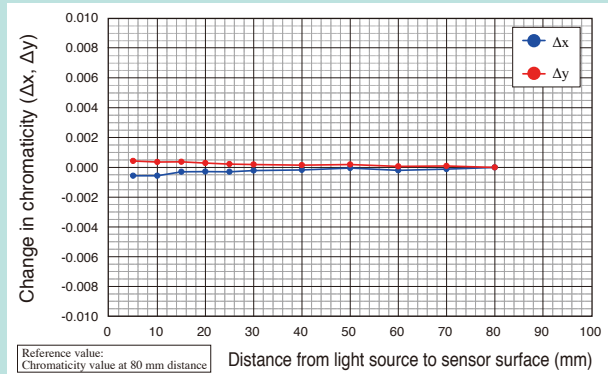
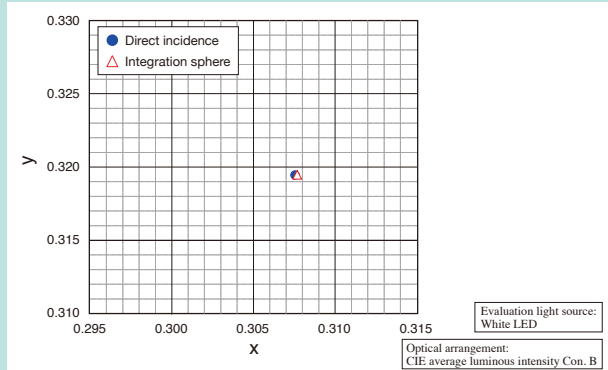

Figure 6. Effect of Measurement Distance (with $\phi 6.3\text{ mm}$ Light Source)

The TM6101 exhibits little change in chromaticity values, whether directly measuring LED chromaticity or using an integration sphere. This feature allows it to be used to test LED devices, LED modules, LED lighting, and other devices under a variety of photometric conditions (see Figure 7).

When using an integration sphere to measure chromaticity, the incident light received by the optical measuring instrument connected to the sphere includes light from a variety of angles. Use of an instrument with high incident angle dependence will yield results that differ significantly from chromaticity values obtained by means of direct measurement. The TM6101's large 11.3 mm aperture diameter for the light detection surface makes it easy to align the optical sensor unit.

Figure 7. Variability in Chromaticity Due to Photometric Conditions (Chromaticity Measured Values for Direct Incidence and Integration Sphere Measurement)



Automatic Testing Functionality

Standard USB 2.0

- The TM6101 can be connected to and automatically controlled by a computer.
- Measured values from the instrument can be received at high speed.

Reference value correction function

The TM6101's sensitivity is corrected based on spectral data for a reference light source provided by the customer and photometric data.

Digital I/O

- Automatic measurement using an external trigger
- Signal output at completion of measurement

Auto-range function

Auto-range functionality can be executed at the start of measurement.

Computer control

A computer is not included and must be provided by the customer.

Standard Windows software

- The instrument ships standard with software for controlling measurement, transferring data, displaying measurement results, and saving data as CSV files.
- Displayed data: Illuminance, luminous intensity, luminous flux, chromaticity (xy), color rendering index (R1 to R15, Ra), correlated color temperature, Δuv , dominant wavelength, excitation purity

Software development library

- A Windows API allows customers to develop their own Windows software.
- Supported development environment: Visual Studio 6.0 to 2008 (VC++, VB, .NET)

Rear of instrument

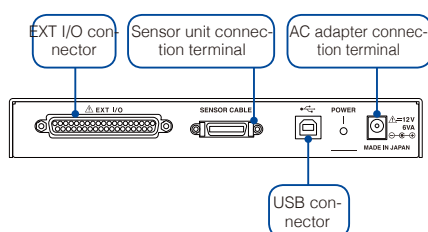

Support for a Variety of Testing Applications

Testing of white LEDs

Measurement of average luminous intensity, chromaticity, and color rendering index

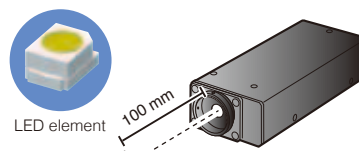

System for measuring average luminous intensity (0.01 sr)

Measurement of total luminous flux, chromaticity, and color rendering index

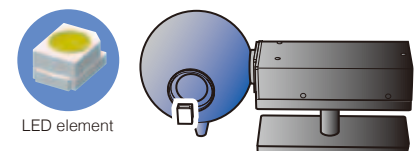

System for measuring total luminous flux

Customer must provide integration sphere and sensor unit mount.

*Can be connected to an integration sphere via a 1-inch port.

Specifications (Product guaranteed for 1 year, Accuracy guaranteed for 1 year, Post-adjustment accuracy guaranteed for 1 year)

Measurement items	(1) Illuminance, Luminous flux, Luminous Intensity (2) Chromaticity (3) Color Rendering Index (4) Correlated Color Temperature and Δuv (5) Dominant wavelength and excitation purity
Measurement range	[Illuminance] 5 lx to 100,000 lx
Applicable Standard	Compliant with special type illuminance measuring instruments* specified in Japanese Industrial Standard (JIS) C 1609-1:2006 Illuminance meters Part 1: General measuring instruments. Performance (1) Illuminance linearity*: 2%±1dgt. (2) Visible range relative special responsivity characteristics*: 1.5% *Terms translated into English by Hioki English translation of JIS C 1609-1:2006 has not been published by Japanese Standards Association. In the event of any doubt arising, the original standard in Japanese is to be evidence.
Spectral responsivity characteristics of colour-matching functions	Performance Meets with tolerance limits specified as Table 1 (Tolerance limits to deviation of spectral responsivity of photo-electric colorimeter) in 5.2 Photoelectric colorimeter of JIS Z 8724:1997 Methods of colour measurement - Light-source colour.
Compensation	(1) Dark current correction (to cancel the dark current offset for each channel); user-selectable averaging count and range settings (all ranges) (2) Input of illuminance, chromaticity, and luminous flux values and calculation of gain correction values; user-selectable averaging count setting (3) Chromaticity value correction function; user-selectable averaging count setting
Post-correction backup	Saving of user correction values: Reference value correction values can be saved on the connected computer.
Interfaces	[USB 2.0] Allows included PC application software or library software to acquire measurement results and control measurement. [Digital I/O] Input: External trigger Photocoupler-isolated, no-voltage contact input Assert: 0 to 1 V (input current: 3 mA), De-assert: Open or 5 to 30 V Output: End of measurement Photocoupler-isolated, NPN open collector DC 30 V, DC50 mA max./ch. Residual voltage: 1.5 V or less (50 mA), 1 V or less (10 mA) Service power supply output (internal power supply) 4.5 to 5 V DC, max. 100 mA DC, with protective ground and isolated from measurement circuitry
Operating temperature and humidity	5 to 35 °C, 80 % rh or lower, Non-condensation
Storage temperature and humidity	-10 to 50 °C, 80 % rh or lower, Non-condensation
Operating environment	Indoors, up to 2000m(6562-ft) ASL
Power supply	AC adapter 9418-15 (AC100 to 240V, 50/60Hz, 6VA)
Dimensions (not including projections)	[Main unit] 210 (W) × 30 (H) × 135 (D) ±1 mm [Sensor unit] 70 (W) × 39.5 (H) × 172 (D) ±1 mm
Mass	[Main unit] 1,000 g ±100 g [Sensor unit] 550 ± 50 g
Optical detector	
Incoming radiation diameter	φ 11.3 mm±0.1 mm
Measurement function	
Control	Controlled by bundled software (USB connection) Start measuring by internal trigger/external trigger
Trigger function	Selection of internal or external trigger [Trigger delay] Max. 1,000 ms
Averaging	The specified number of measured values is averaged to calculate the reading. [Number of averaging time] 1 to 100 times
Auto-range function	The auto-range function can be executed at the start of measurement. Includes range peak hold function. User-selectable range tolerance (%): The measurement range tolerance can be set so that the amount of light generated by the measurement target does not exceed the range limits.
Display (display measured results by bundled software)	
Illuminance	[Display resolution] 0.1 lx
Luminous flux	[Display resolution] 0.01 lmm
Luminous Intensity	[Display resolution] 0.01 mcd
Chromaticity	[Display range] 0.0000 to 1.0000 [Resolution] 0.0001
Color Rendering Index	[Resolution] 1 (Special color rendering index R1 to R15) 0.1 (Average color rendering index Ra)
Correlated Color Temperature	[Resolution] 1 K (Correlated Color Temperature) When Δuv < 0.02, 0.0001 (Δuv)
Dominant wavelength	[Display range] 380 to 700 nm [Display resolution] 0.1 nm (Dominant wavelength), 0.1 % (excitation purity)

Measurement software (computer application software)	
Operating environment	PC capable of running supported operating systems Pentium 3 (1 GHz) or better CPU, 256 MB or more memory Video functionality capable of displaying at least 256 colors at a resolution of at least 1,024 × 768/ USB 2.0 interface/ CD-ROM drive (for software installation)/ 100 MB free hard disk space
Supported operating systems	Windows 8/ 7 (32bit/ 64bit), Vista (32bit), XP (Japanese or English)
Supported measuring instruments	TM6101 only (when connected to computer via USB) Up to 4 instruments can be connected simultaneously. (Only 1 instrument can be connected when using the PC application software.)
Software configuration	(1) Measurement software (PC application software) (2) Measurement library
Control	[Start/stop measurement] Start measurement using internal or external trigger. [Measurements and calculations] See "Measurement items" on this page for details. [Auto-range function] Auto-range functionality can be executed at the start of measurement.
Setting item	[Measurement modes] Normal measurement mode, AC-lit measurement mode [Trigger delay] 0 to 1000 ms (1 ms resolution) [Sensitivity range] High, Low [Integration time] 0.1 (Sensitivity Low only), 0.5, 1.0, 2.0, 4.0, 8.0, 10.0, 16.666, 20.0, 33.333, 40.0 msec [Number of averaging time] 1 to 100 times [Measurement modes] Normal measurement mode, AC-lit measurement mode [Measurement ranges] 1 to 3 (*AC-lit measurement mode only) [Commercial power supply frequencies] 50 Hz, 60 Hz (*AC-lit measurement mode only) [Luminous intensity measurement range] 10 to 10,000 mm
Display items	[Measured results] See "Display" on this page for details. [Graph display] Measured chromaticity values are plotted using x and y chromaticity coordinates. [Detection level] Detection level is displayed as % f.s.
Data storage	Measurement results can be saved as a CSV file. For information on the type of data that can be saved, see "Display" on this page. Data can be saved automatically.
Compensation	See "Compensation" on this page for details.
Measurement library	
Supported development environment	Visual Studio 6.0 to 2008 (VC++, VB, .NET) (The library is 32-bit DLL.)
Measuring instrument control	See "Control" under "Measurement software" on this page for details.
Acquisition of measurement results	Data can be acquired after measurement completes. Measurement items that can be acquired: Illuminance, luminous flux, chromaticity, color rendering index, correlated color temperature, ΔUV, dominant wavelength, and excitation purity
Correction functionality	See "Compensation" on this page for details.

Sensor unit dimensional drawing (mm)

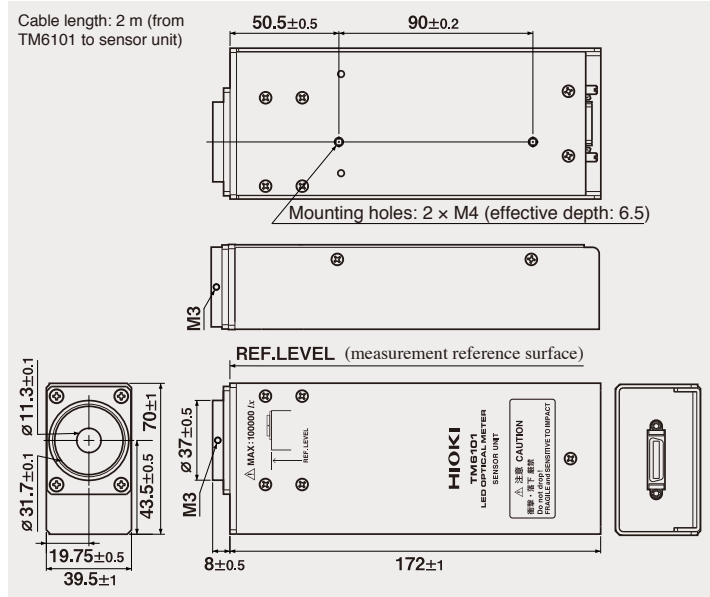

Model : LED OPTICAL METER TM6101

Model No. (Order Code)
TM6101

Note: Can be connected to an integration sphere via a 1-inch port.
Accessories: AC adapter 9418-15 ×1, USB cable ×1, Main unit/ sensor unit connection cable (2 m, 6.56 ft) ×1, Cap ×1, Connecting port connecting screws ×4, Ferrite cores ×3, Rubber feet ×4, Instruction manual ×1, CD-R (PC application software, Measurement library) ×1

Related measuring instruments

AC/DC POWER HITESTER

For measuring LED lighting power consumption
For measuring LED inrush current

3334 (1.00 mA to 30.00 A)
3334-01 (w/GP-IB interface)



Note: Company names and Product names appearing in this catalog are trademarks or registered trademarks of various companies.

HIOKI

HIOKI E. E. CORPORATION

HEADQUARTERS
81 Koizumi, Ueda, Nagano, 386-1192, Japan
TEL +81-268-28-0562 FAX +81-268-28-0568
http://www.hioki.com / E-mail: os-com@hioki.co.jp

HIOKI USA CORPORATION
TEL +1-609-409-9109 FAX +1-609-409-9108
http://www.hiokiusa.com / E-mail: hioki@hiokiusa.com

HIOKI (Shanghai) SALES & TRADING CO., LTD.
TEL +86-21-63910090 FAX +86-21-63910360
http://www.hioki.cn / E-mail: info@hioki.com.cn

HIOKI SINGAPORE PTE. LTD.
TEL +65-6634-7677 FAX +65-6634-7477
E-mail: info-sg@hioki.com.sg

HIOKI KOREA CO., LTD.
TEL +82-2-2183-8847 FAX +82-2-2183-3360
E-mail: info-kr@hioki.co.jp

DISTRIBUTED BY